



SURGICAL
TECHNIQUE



MEDSHAPE®

DYNANAIL HYBRID™

ACTIVE, ADAPTIVE HEALING FOR SUBTALAR FUSION

NAIL SYSTEM





**THE DYNAMIC
COMPRESSIVE POWER
OF A NAIL WITH THE
SIMPLE, INTUITIVE
INSERTION OF A SCREW**

INTRODUCTION	3
INDICATIONS AND CONTRAINDICATIONS	4
TECHNICAL SPECIFICATIONS	5
DESIGN FEATURES	6
INSTRUMENT TRAY	7
QUICK REFERENCE GUIDE	9
SURGICAL TECHNIQUE	10
ORDERING INFORMATION	27

DJO® is a manufacturer of orthopedic implants and does not practice medicine. This surgical technique was prepared in conjunction with licensed health care professionals. The treating surgeon is responsible for determining the appropriate treatment, technique(s), and product(s) for each individual patient.

See package insert for complete list of potential adverse effects, contraindications, warnings and precautions.

A workshop training is recommended prior to performing your first surgery. All non-sterile devices must be cleaned and sterilized before use.

Multi-component instruments must be disassembled for cleaning. Please refer to the corresponding assembly/disassembly instructions, if applicable. Please remember that the compatibility of different product systems has not been tested unless specified otherwise in the product labeling.

The surgeon must discuss all relevant risks including the finite lifetime of the device with the patient.

WHY DYNANAIL HYBRID™ FOR SUBTALAR FUSION?

Subtalar fusion surgery is performed to relieve pain and correct severe foot deformity by achieving solid bony union. According to the Association for the Study of Internal Fixation principles, compression across a fusion site is important for promoting bone healing. Compression also provides stability by maximizing bone-to-bone contact and limiting micro-motion. The clinical results for tibiotalocalcaneal (TTC) fusion support the biomechanical basis for applied compression at the joint site as both external and internal fixation devices have evolved over time to better meet this need.¹

The DynaNail Hybrid™ Fusion System features MedShape's patented and proven superelastic NiTiNOL Compressive Element technology miniaturized for use in subtalar fusion.^{2,3} Unlike traditional screws that lose compression within 1 mm of bone resorption, DynaNail Hybrid is the only internal device for subtalar fusion – along with the DynaNail Mini® – that maintains active compression post-surgery in response to bone resorption or settling. The implant features an anatomically friendly hybrid screw/nail design; the interlocking Transverse Calcaneal Screw offers the stability of a nail and prevents device migration, while the proximal talar threads allow for simple, intuitive insertion.

The DynaNail Hybrid Fusion System is offered in multiple lengths to accommodate varying patient

anatomies, with the amount of available NiTiNOL compression increasing with implant length. The Compressive Element is housed inside a rigid outer titanium body. The DynaNail Hybrid comes with the NiTiNOL Element pre-stretched and pre-loaded on a disposable Nail Guide for procedural efficiency. The system also features a rigid, radiolucent carbon fiber-filled polyether ether ketone (PEEK) Targeting Frame that is used to precisely position the implant across the joints and accurately drill and place the Screw. Housed in a single sterilization tray, the Frame and accompanying instrumentation provide the surgeon with a simple, reliable surgical approach. The DynaNail Hybrid is implanted using the same instrumentation as the DynaNail Mini® for further ease and flexibility.

The streamlined surgical technique involves first Nail Implant placement, then application of manual compression, insertion of the Transverse Calcaneal Screw, and finally, the release of the Nail Implant from the Targeting Frame.

1. Dupont KM, Shibuya N, Bariteau JT. Tibiotalocalcaneal Arthrodesis with Intramedullary Nails – Mechanobiological Background and Evolution of Compressive Technology. *Global J Orthopedic Research*, 2019. 1(5).

2. Yakacki CM, Gall K, Dirschl DR, Pacaccio DJ. Pseudoelastic intramedullary nailing for tibio-talo-calcaneal arthrodesis. *Expert Rev Med Devices*, 2011; 8(2): 159-66.

3. Ford SE, Kwon JY, Ellington K. Tibiotalocalcaneal Arthrodesis Utilizing a Titanium Intramedullary Nail With an Internal Pseudoelastic Nitinol Compression Element: A Retrospective Case Series of 33 Patients. *J Foot Ankle Surg*, 2019. 58(2):266-272.

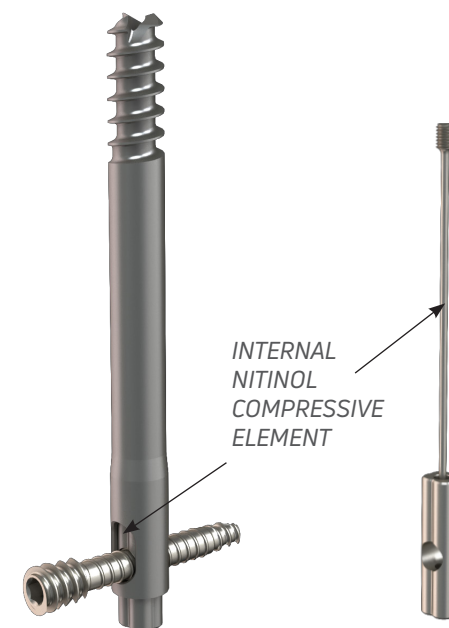

INDICATIONS

DYNANAIL HYBRID™ FUSION SYSTEM

The DynaNail Hybrid™ Fusion System is indicated for:

- Fracture fixation.
- Osteotomies.
- Reconstruction procedures.
- Non-unions.
- Fusions of large bones in the foot and ankle.

CONTRAINDICATIONS

DYNANAIL HYBRID FUSION SYSTEM

The DynaNail Hybrid Fusion System is contraindicated for:

- Patients with an active local or systemic infection.
- Patients with an active soft tissue infection or osteomyelitis of foot and ankle.
- Patients with severe peripheral vascular disease.
- Patients with an obliterated medullary canal or other conditions that tend to retard healing, such as blood supply limitations or previous infections.
- Skeletally immature patients where the implant would cross open epiphyseal plates.
- Patients with a dysvascular limb.
- Patients with an insufficient quantity or quality of bone to permit fusion of the joints or stabilization of the arthrodesis.
- Patients with conditions that restrict their ability or willingness to follow post-operative instructions during the healing process.
- Patients with suspected foreign body sensitivity, or documented metal allergy or intolerance. Where material sensitivity is suspected, appropriate tests should be conducted and sensitivity ruled out prior to implantation.

NAIL IMPLANT

Available in 7 mm diameter and 60 - 100 mm lengths in 10 mm increments.

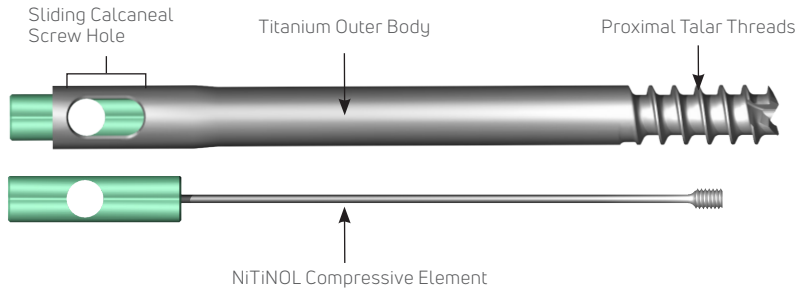

7 X 60 MM

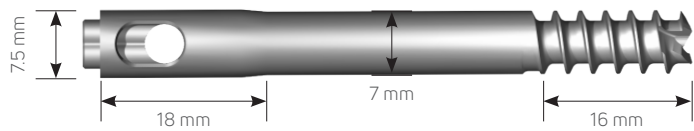

7 X 70 MM

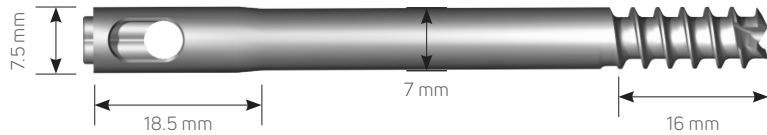

7 X 80 MM

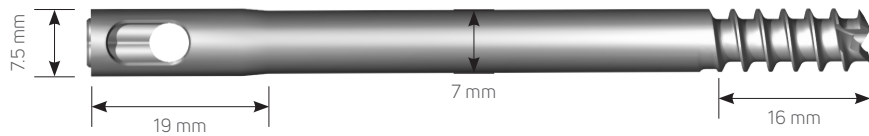

7 X 90 MM

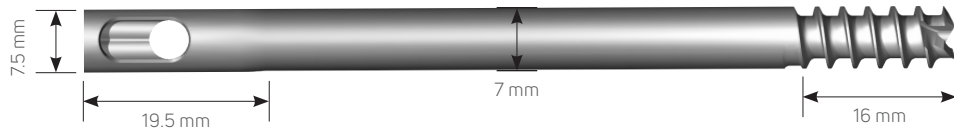

7 X 100 MM

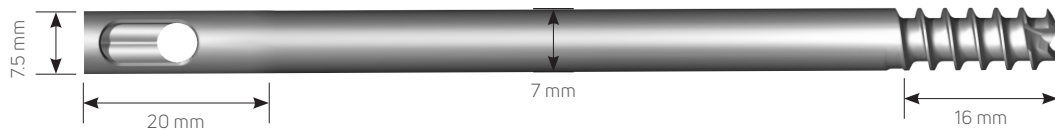

HEADLESS SCREW

- 4 mm Diameter
- Available in 14 - 40 mm lengths in increments of 2 mm



END CAP

- 2 mm Hex Drive
- Available in +3 and +6 mm Head heights

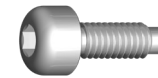

AMOUNT OF POST-OPERATIVE COMPRESSION BY IMPLANT LENGTH

NAIL LENGTH	COMPRESSION
60 MM	2.2 MM
70 MM	3.0 MM
80 MM	3.8 MM
90 MM	4.5 MM
100 MM	5.3 MM

The DynaNail Hybrid™ Fusion System maintains active compression using its proprietary internal NiTiNOL Compressive Element that automatically responds to changes in loading due to bone resorption or settling. The unloading of the Compressive Element can be visualized on fluoroscopy via translation of the screw hole in the Sliding Element through the slot in the Outer Body. This is best visualized on anterior-posterior radiographs.

OUT OF THE PACKAGE

The DynaNail Hybrid is provided with the NiTiNOL Compressive Element pre-stretched and pre-loaded on the disposable Nail Guide.

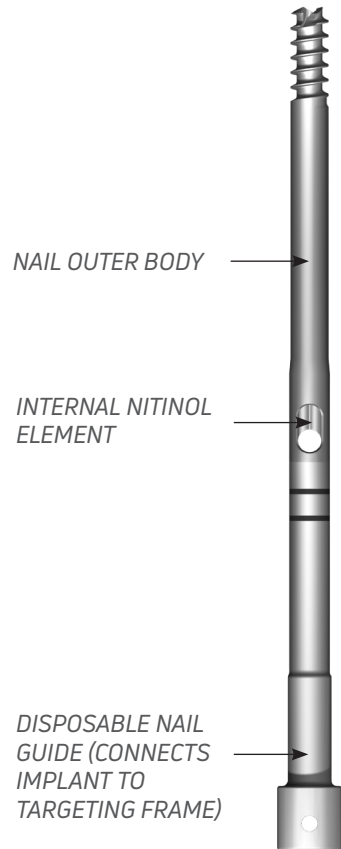

IMMEDIATE POST-SURGERY

Once the Targeting Frame is removed, the Compressive Element is now in its stretched, activated position with the calcaneal screw oriented in the distal end of the slot and the Sliding Element extending plantarly from the Nail Body.

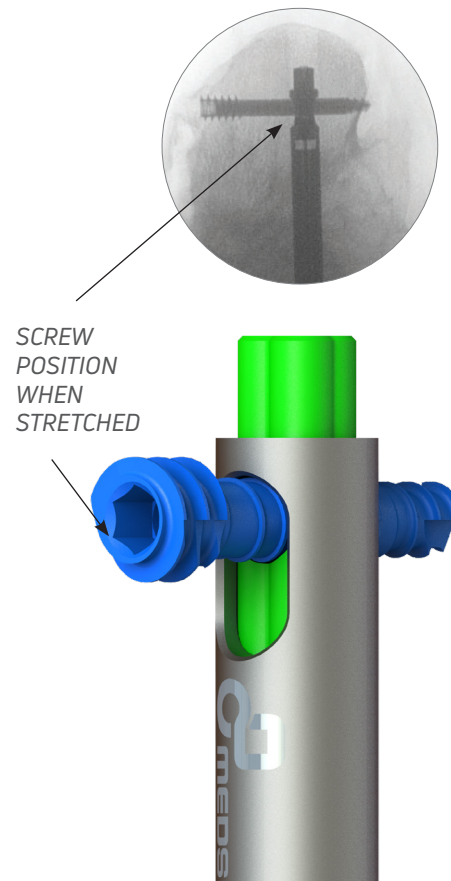

WEEKS TO MONTHS POST-SURGERY

As the Compressive Element unloads (i.e. recovers its stretched length) in response to bone resorption or settling, the calcaneal screw will progressively shift proximally. The Compressive Element has completely unloaded when the calcaneal screw is at the proximal end of the slot and the transparent region is no longer visible.

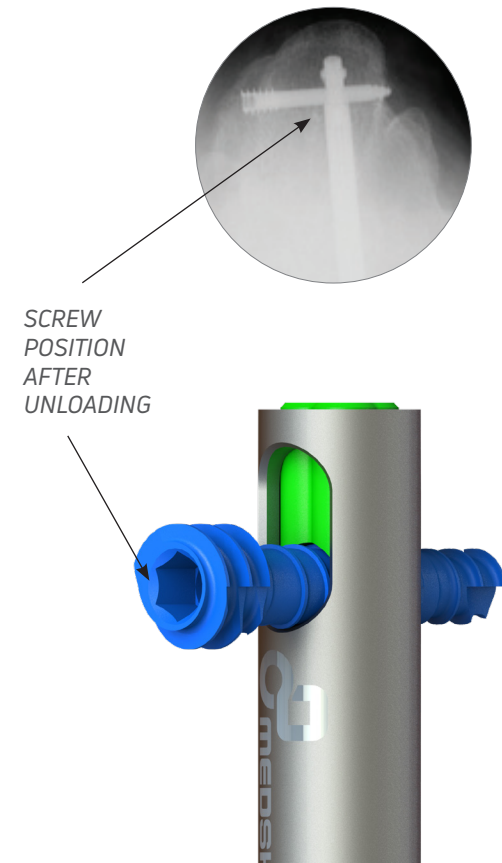

The DynaNail Hybrid™ is implanted using the same Instrument Tray as the DynaNail Mini®. Instruments highlighted in red are part of the DynaNail Hybrid® surgical technique.

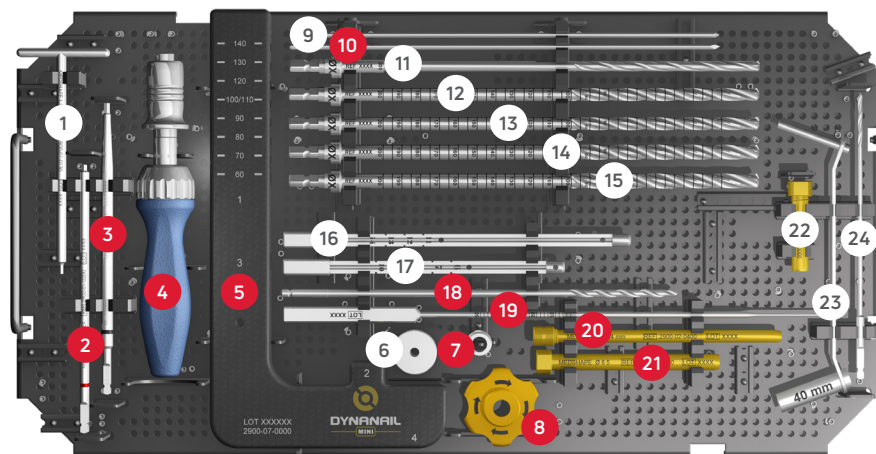

INSTRUMENT CASE, TOP TRAY

#	DESCRIPTION	PART #	QTY
1	2.0 MM ENDCAP T-HANDLE DRIVER	2900-01-0201	2
2	2.0 MM HEX DRIVER	2900-01-0200	2
3	3.0 MM HEX DRIVER	2900-01-0300	2
4	BLUE-HANDLE RATCHET DRIVER	2900-12-0001	1
5	TARGETING FRAME	2900-07-0000	1
6	RETENTION KNOB	2900-10-0000	1
7	BONE APPPOSITION SLEEVE	2900-22-0078	1
8	COMPRESSION KNOB	2900-23-0000	1
9	2.0 MM STEINMANN PIN	2200-19-0020	4
10	GUIDEWIRE, 2.4 X 229 MM	2900-04-0229	3
11	5.0 MM CANNULATED DRILL	2900-16-050	1
12	7.0 MM CANNULATED REAMER	2900-16-070	1

#	DESCRIPTION	PART #	QTY
13	7.5 MM CANNULATED REAMER	2900-16-075	1
14	8.0 MM CANNULATED REAMER	2900-16-080	1
15	8.5 MM CANNULATED REAMER	2900-16-085	1
16	IMPLANT TRIAL (110-140 MM)	2900-15-0002	1
17	IMPLANT TRIAL (60-100 MM)	2900-15-0003	1
18	4.0 MM TRANSVERSE SCREW DRILL	2900-03-0400	2
19	SCREW DEPTH GAUGE	2900-17-0000	1
20	4.0 MM GUIDE SLEEVE	2900-02-0400	2
21	6.5 MM DRILL GUIDE	2900-02-0650	2
22	PARALLEL PIN GUIDE	2900-20-0000	1
23	SOFT TISSUE PROTECTOR	2900-13-0000	1
24	2.5 MM FENESTRATION DRILL	2201-09-0025	1

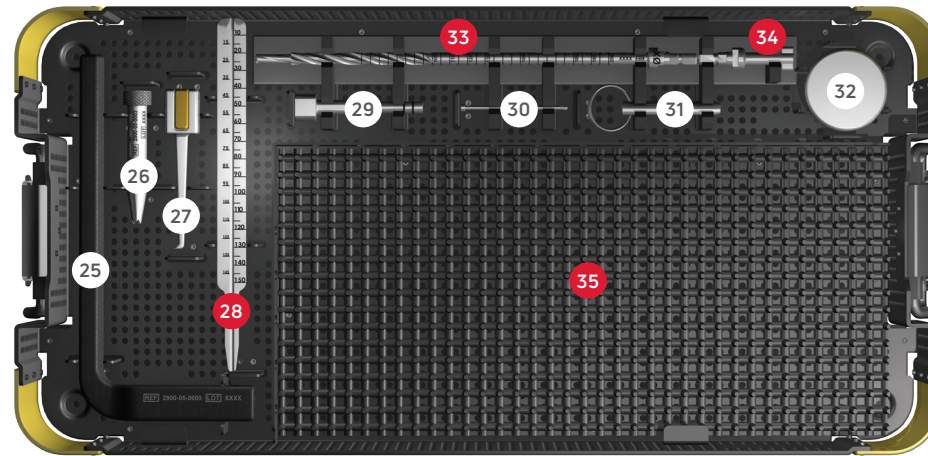

INSTRUMENT CASE, BOTTOM TRAY

#	DESCRIPTION	PART #	QTY
25	GUIDEWIRE GUIDE ARM	2900-05-0000	1
26	GUIDEWIRE GUIDE CANNULA	2900-05-0003	1
27	GUIDEWIRE GUIDE STYLUS	2900-05-0001	1
28	GUIDEWIRE DEPTH GAUGE	2900-17-0001	1
29	REMOVAL ATTACHMENT	2900-18-0000	1
30	REMOVAL CONNECTION SCREW	2900-24-0250	1
31	REMOVAL STRIKE PLATE PIN	2900-21-0001	1
32	REMOVAL STRIKE PLATE	2900-21-0000	1
33	7.5 STEP DRILL, HYBRID	2901-01-0075	1
34	NAIL GUIDE ADAPTOR, HYBRID	2901-00-0078	1
35A	T15 REMOVAL DRIVER, HYBRID	2901-02-0015	1
35B	1.3 MM T-HANDLE DRIVER	2900-01-0130	1

The following is a general overview of the DynaNail Hybrid™ Surgical Technique intended to be used as an easy reference. A more detailed surgical technique including technical tips and pearls is available in the following pages.

**STEP 1: PLACE GUIDEWIRE,
DETERMINE IMPLANT LENGTH**

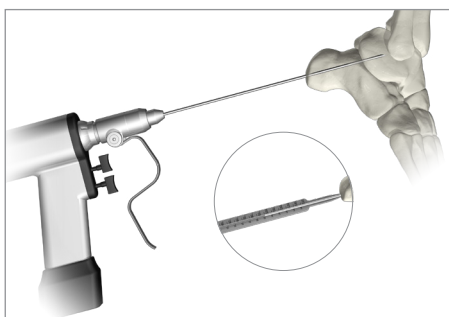

STEP 2: REAM ENTRY CANAL

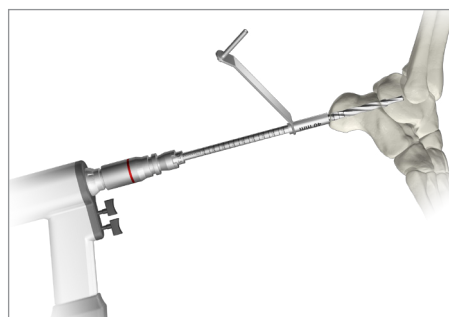

**STEP 3: LOAD MANUAL
COMPRESSION KNOB**

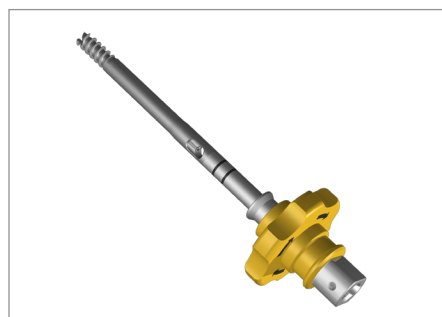

STEP 4: INSERT WITH HANDLE

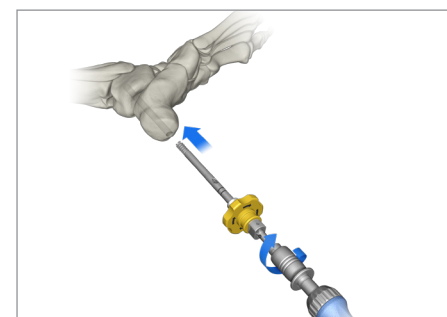

STEP 5: MANUALLY COMPRESS JOINT

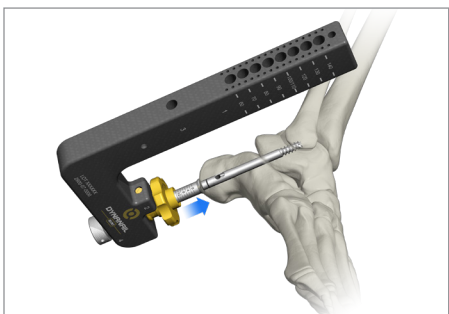

STEP 6: DRILL, INSERT SCREW

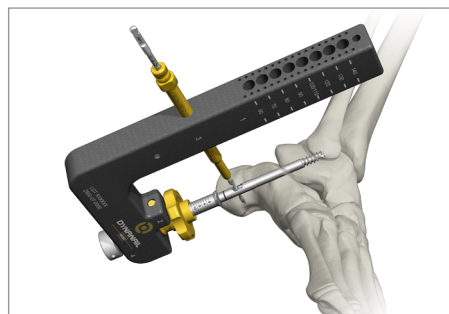

STEP 7: RELEASE NAIL

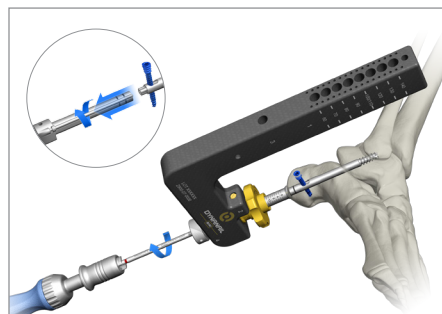

STEP 8: INSERT ENDCAP

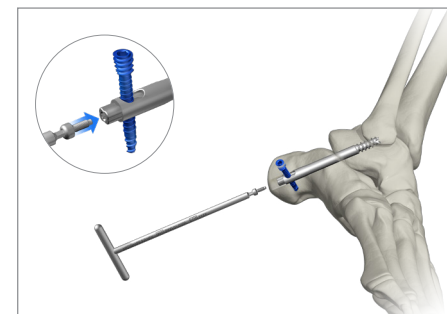

1. SURGICAL APPROACH

With the patient in a supine or lateral position, make a lateral incision (**FIGURE 1**). The extensor digitorum brevis can be split or elevated in a distal direction. Ensure that the crossing branch of the sural nerve to the dorsal intermediate branch of the superficial peroneal nerve and peroneal tendons are protected during exposure.

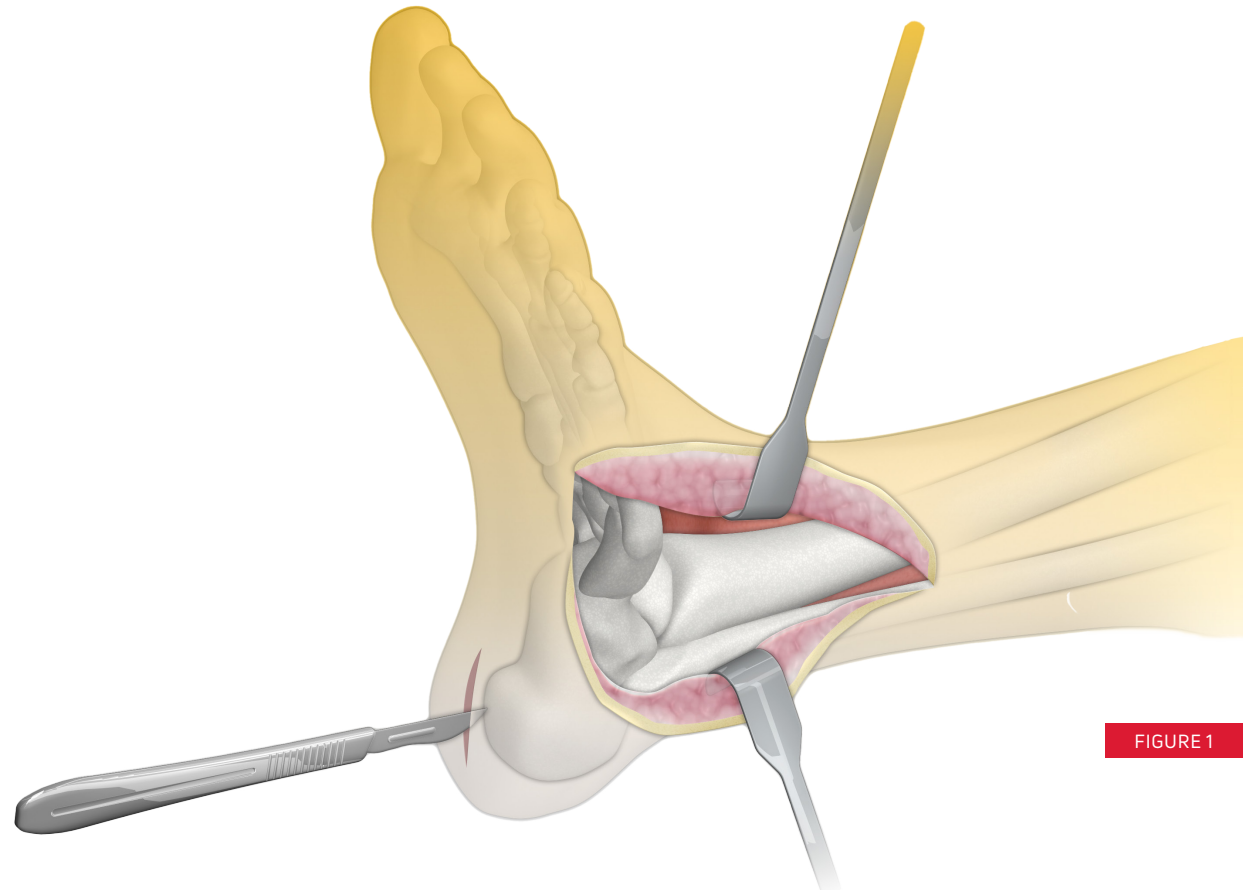

FIGURE 1

2. JOINT PREPARATION

Instruments used:

1. Fenestration Drill, 2.5 mm x 6" (24)
2. Soft Tissue Protector (23)

Using a lateral approach, reduce the joint to the correct position by first exposing the subtalar joint. Distract the joint using a lamina spreader. Prepare the joint by completely removing cartilage from the posterior and middle facets using a sharp osteotome, a curette, and a rongeur until there is exposed bleeding subchondral bone. Leave the overall contours of the bones intact. Once all cartilage is removed, use a sharp osteotome to "fish-scale" the posterior and middle facets. The 2.5 mm Fenestration Drill with the 2.5 mm Drill Guide on the Soft Tissue Protector can be used to aid in creating bleeding bone and feathering the joint surface (**FIGURE 2**). Ensure that the bleeding bone surfaces are in apposition before proceeding. Place any graft material if desired.



FIGURE 2

3. GUIDEWIRE PLACEMENT

Instruments used:

1. Guidewire, 2.4 mm x 229 mm (10)

Make a 2 cm incision down to the bone at the posterior-plantar junction of the calcaneal tuberosity (**FIGURE 3**).

Compress the joint before placing the Guidewire and keep joint in proper orientation and under compression throughout procedure. Steinmann pins may be used to fixate the subtalar joint if desired.

TIP:

Verify Guidewire placement under fluoroscopy in at least two planes. Additional oblique views may be helpful to visualize the wire trajectory. The Guidewire tip should be positioned in the talar body and centered medial-lateral position in the talus.

Ensure there is sufficient Guidewire length in the talus to allow for the threaded tip of the Implant to entirely cross the joint.

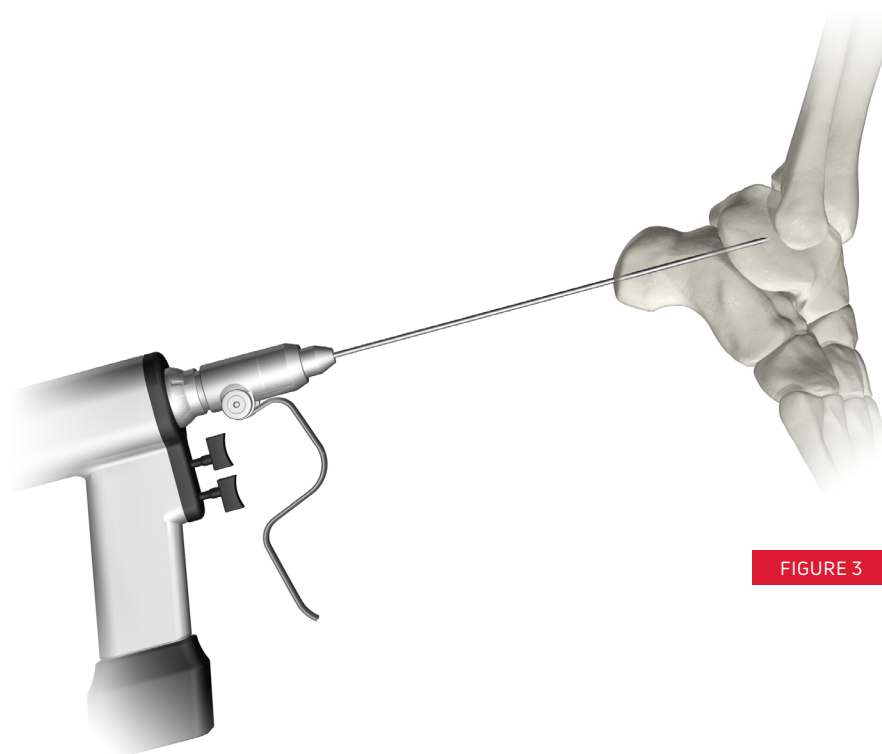
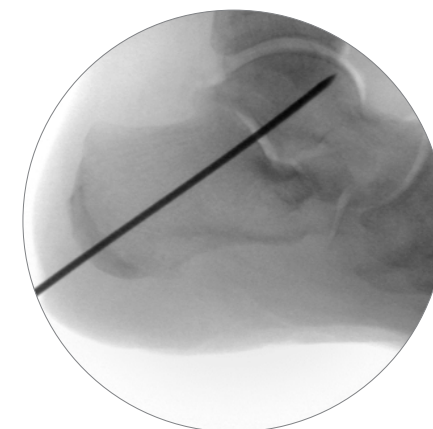
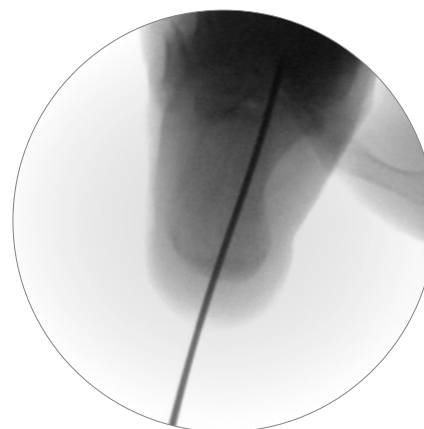

FIGURE 3



4. DETERMINE IMPLANT LENGTH

Instruments used:

1. Guidewire Depth Gauge (28)

Place the Guidewire Depth Gauge onto the Guidewire and rest firmly against the calcaneus (**FIGURE 4**). Read the length from end of the Guidewire (**A**).

TIP:

Select an Implant length that is at least 5 mm shorter than the Depth Gauge reading to allow the Implant to be inserted sub-flush and to accommodate for Manual Compression.

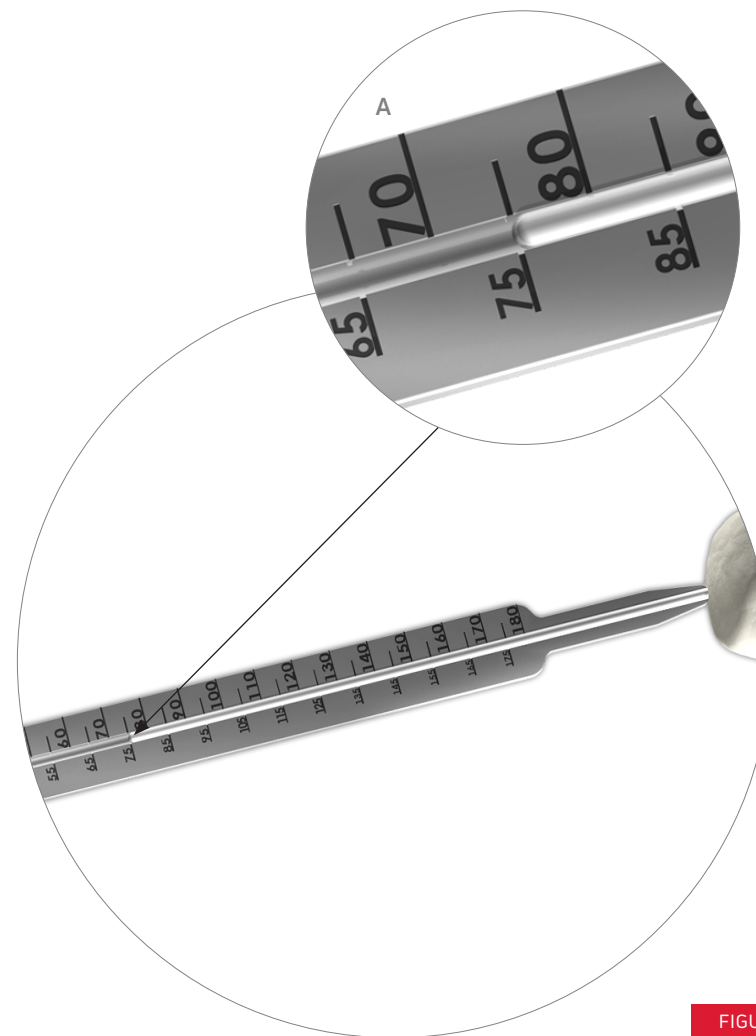

FIGURE 4

5. REAM ENTRY CANAL

Instruments used:

1. Soft Tissue Protector (23)
2. Cannulated Step Drill 7.5 mm (33)

Place the Soft Tissue Protector over the Guidewire against the posterior aspect of the calcaneus. Insert the cannulated Step Drill over the Guidewire into the Soft Tissue Protector. Drill over the path of the Guidewire until the proximal tip of the Drill is a few mm distal to the anterior cortex of the talus (**FIGURE 5**).

TIP:

Use fluoroscopy while reaming to ensure that:

- Drill is not advanced further than the Guidewire.
- Distal stepped portion of the Drill breaches the subtalar joint.

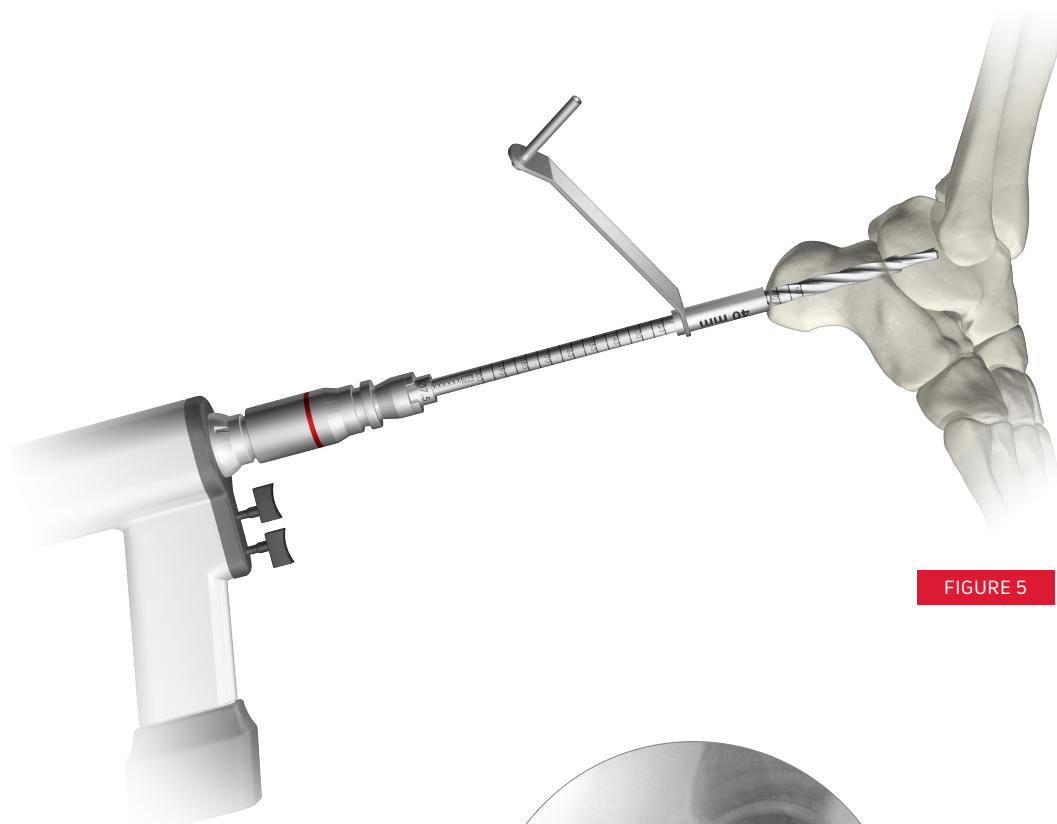

FIGURE 5



6. IMPLANT ATTACHMENT

Instruments used:

1. Bone Apposition Sleeve (7)
2. Compression Knob (8)
3. DynaNail Hybrid™ Implant

Thread the Bone Apposition Sleeve onto the Compression Knob by turning counter-clockwise until it stops (**FIGURE 6**). With the Inner Sleeve Oriented Up, advance the Manual Compression Knob over the DynaNail Mini Assembly and down until it clicks into place (**FIGURE 7**).

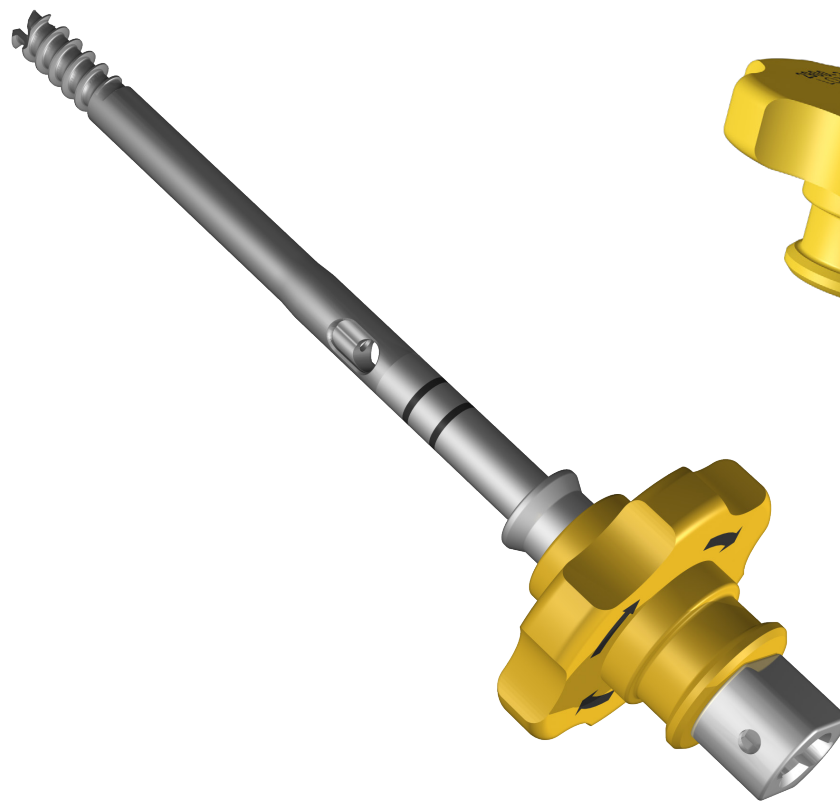

FIGURE 7

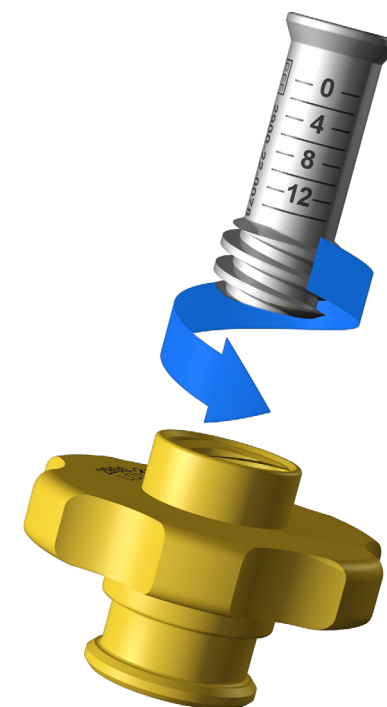

FIGURE 6

7. IMPLANT INSERTION

Instruments used:

1. Nail Guide Adaptor (34)
2. Blue-Handle Ratchet Driver (4)

Attach the Nail Guide Adaptor to the Blue Handle Ratchet Driver (A).

Insert the Implant into the reamed canal and advance the proximal threads of the Hybrid Implant assembly by using the Nail Guide Adaptor (FIGURE 8).

The Implant is inserted until the proximal threads are completely seated in the talus and the distal end of the Implant is approximately 5 mm sub flush from the end of calcaneus.

Use fluoroscopy to determine that proper depth has been reached.

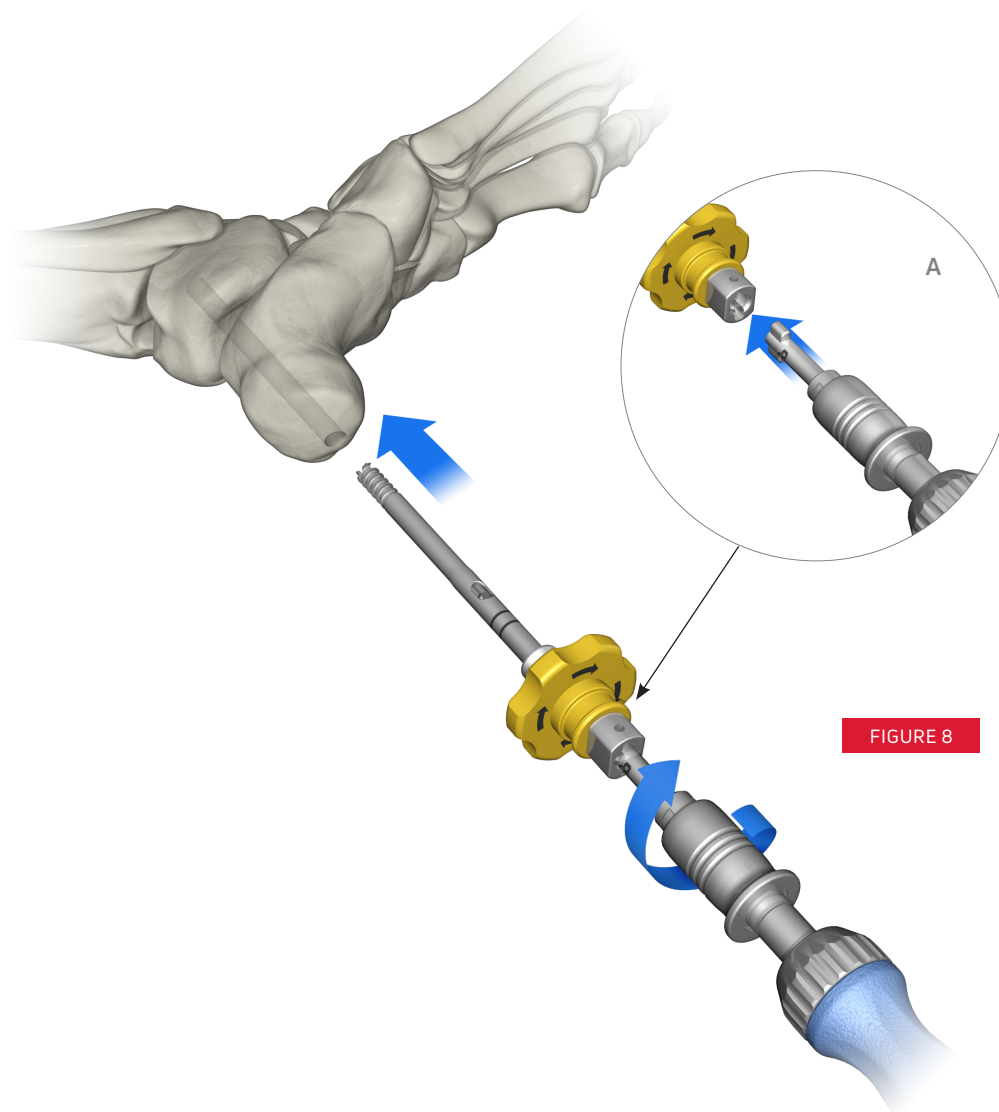

TIP:

- The hole on the Nail Guide provides the orientation of the hole in the Implant for the calcaneal Headless Screw.
- Check Implant positioning on A-P and lateral fluoroscopy before proceeding to the next step.

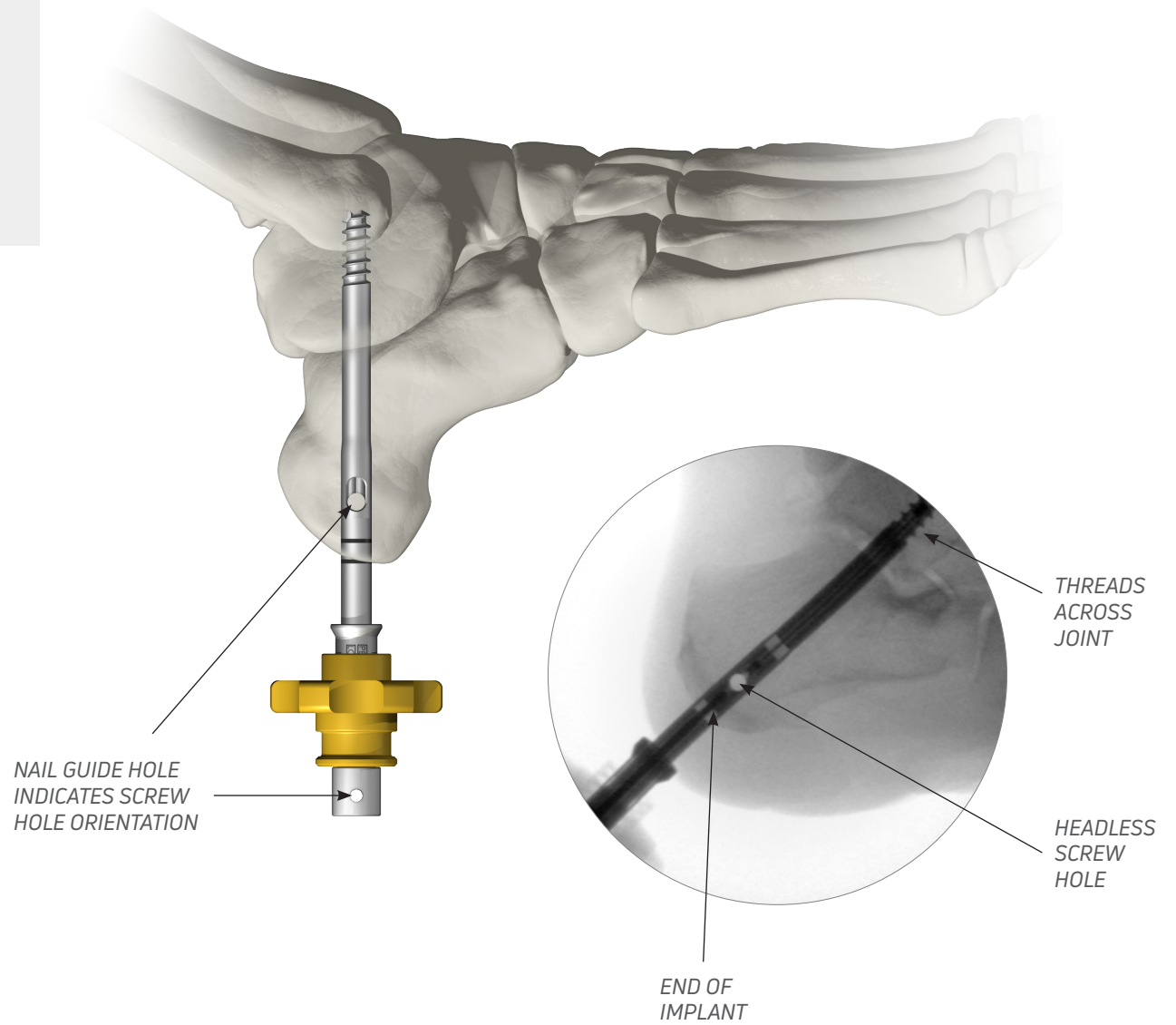

8. TARGETING FRAME ATTACHMENT

Remove the Blue Handle Ratchet Driver and attach the DynaNail Hybrid™ Implant Assembly onto the Targeting Frame (FIGURE 9). Turn the Retention Knob clockwise to securely tighten (A).

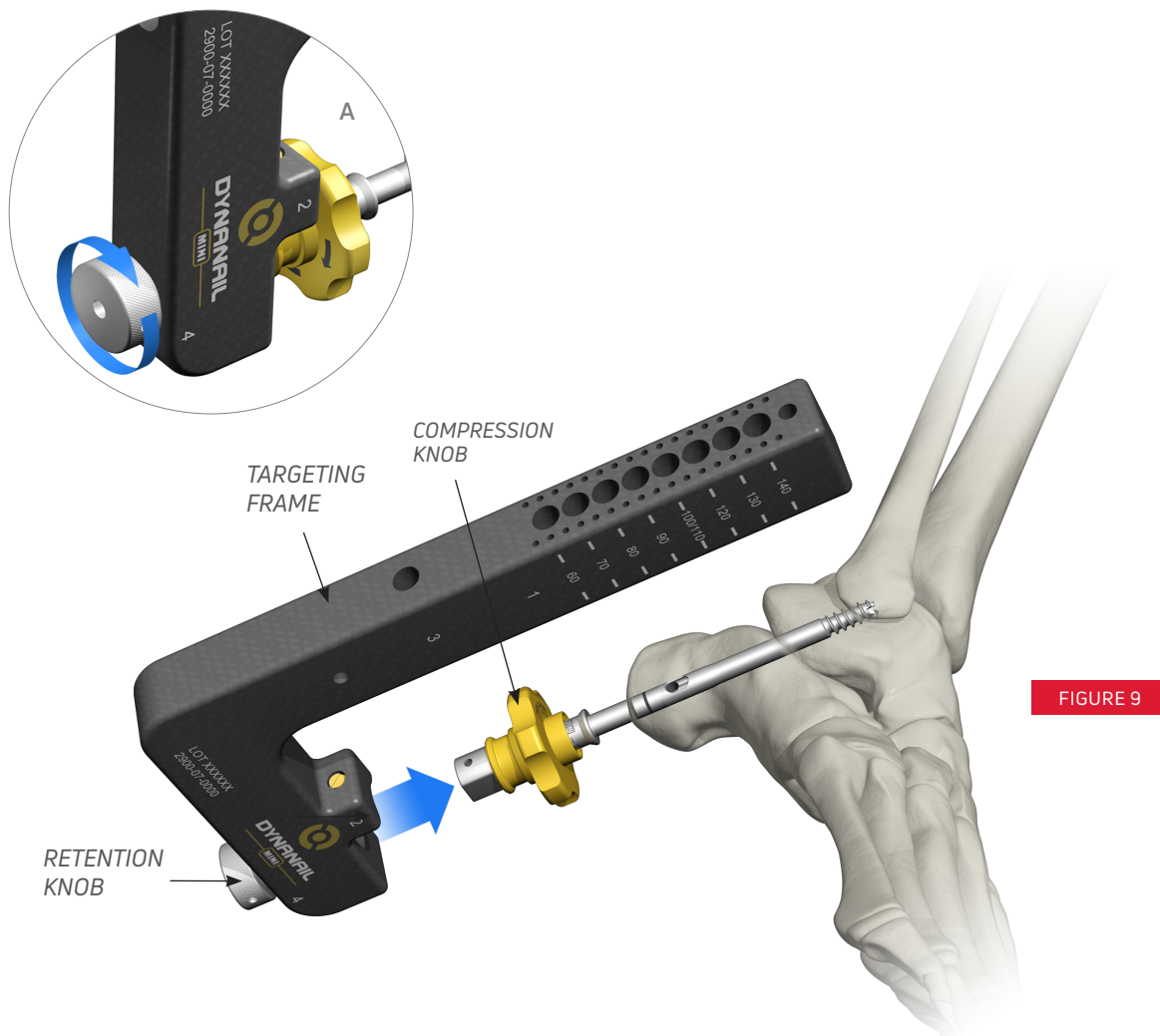

FIGURE 9

9. APPLY MANUAL COMPRESSION

Instruments used:

1. Targeting Frame (5-8)

Ensure the plantar incision is big enough for the Bone Apposition Sleeve to butt against the bone before applying manual compression (**FIGURE 10**). To apply manual compression, turn the Manual Compression Knob in the direction indicated by the arrows on the Knob (**A**).

The approximate amount of manual compression applied can be determined by reading the laser markings on the Bone Apposition Sleeve of the Targeting Frame and taking the difference before and after applying manual compression.

IMPORTANT NOTE: The Manual Compression Knob will disengage from the Targeting Frame once the distal end of the Implant has reached the posterior cortex of the calcaneus to prevent it from being positioned outside the bone.

TIP:

Turn the Manual Compression Knob until **finger tight** to get bony apposition at the Subtalar joint.

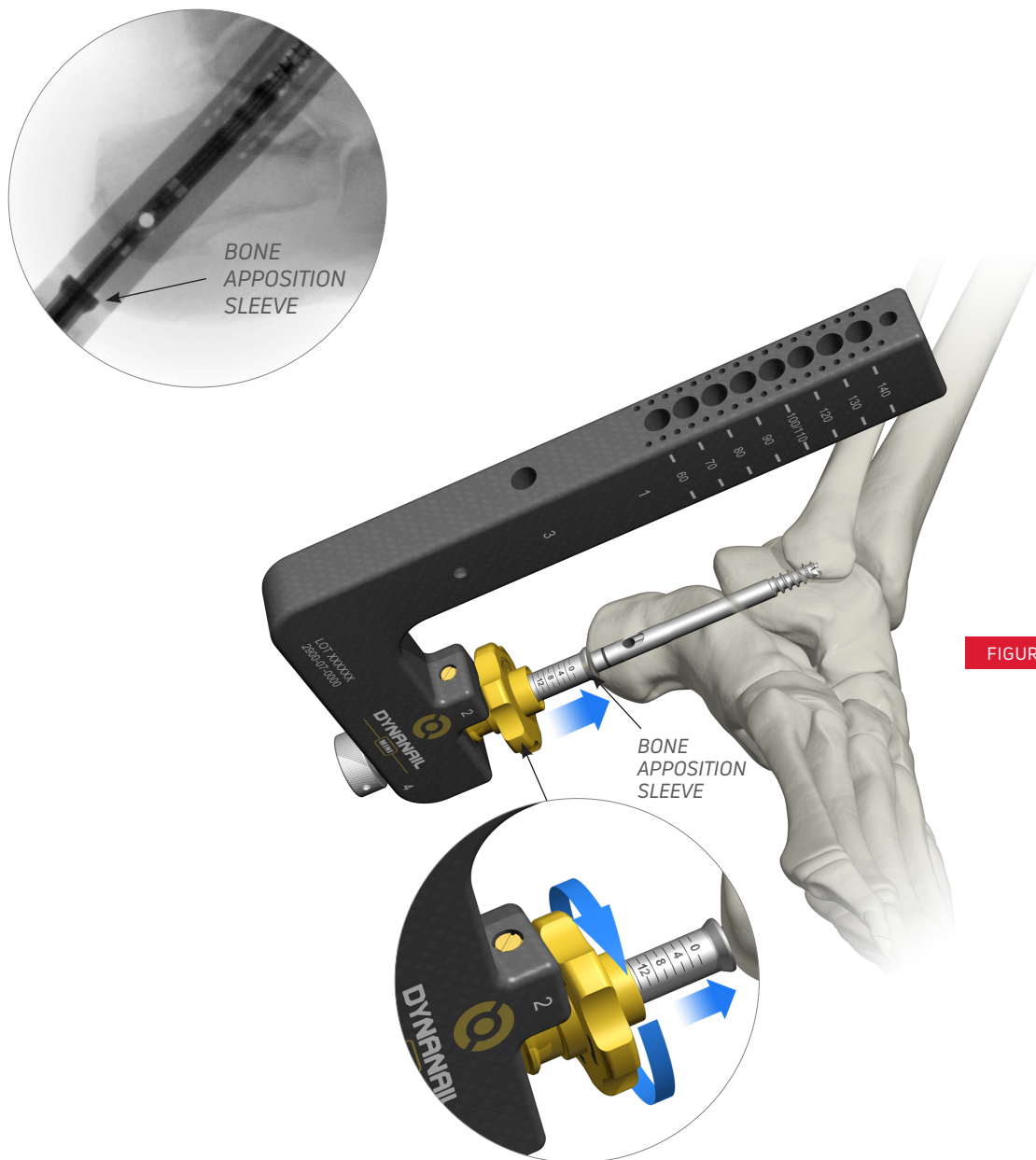

FIGURE 10

10. DRILL CALCANEAL SCREW HOLE

Instruments used:

1. 6.5 mm Guide Sleeve (21)
2. 4 mm Drill Guide (2)
3. 4 mm Transverse Screw Drill (18)

Thread the 4 mm Drill Guide into the 6.5 mm Guide Sleeve. Insert the Guide Sleeve/Drill Guide Assembly into the distal hole on the Targeting Frame. Make an incision parallel to the sural nerve down to the calcaneus. Advance the Drill Guide Assembly down close to the bone, but keep from butting directly against it.

Using the 4 mm Transverse Stepped Drill, drill to the medial cortex through the proximal screw hole in the Implant (**FIGURE 11**). Use fluoroscopy to ensure full drill depth has been reached. Advance the Drill Guide against the bone prior to the next step.

TIP:

Do NOT advance the drill tip beyond the medial cortex such that the Drill extends past the taper. The end of the Headless Screw is tapered and will lose purchase on far cortex if over-drilled.

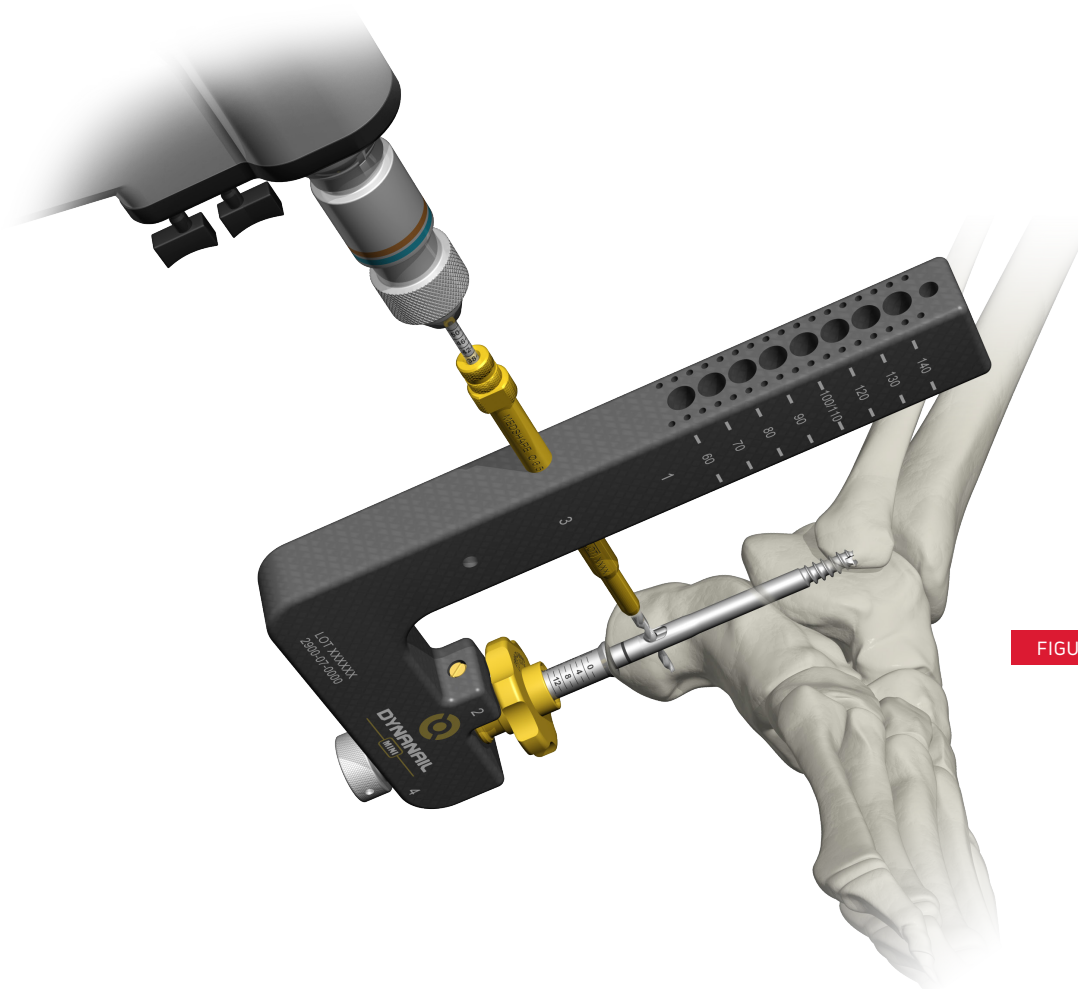

FIGURE 11

11. MEASURE SCREW LENGTH

There are two methods for determining screw length:

1. With the Drill Guide abutted to the bone, read the laser marks on the Drill off the back of the Drill Guide (FIGURE 12).

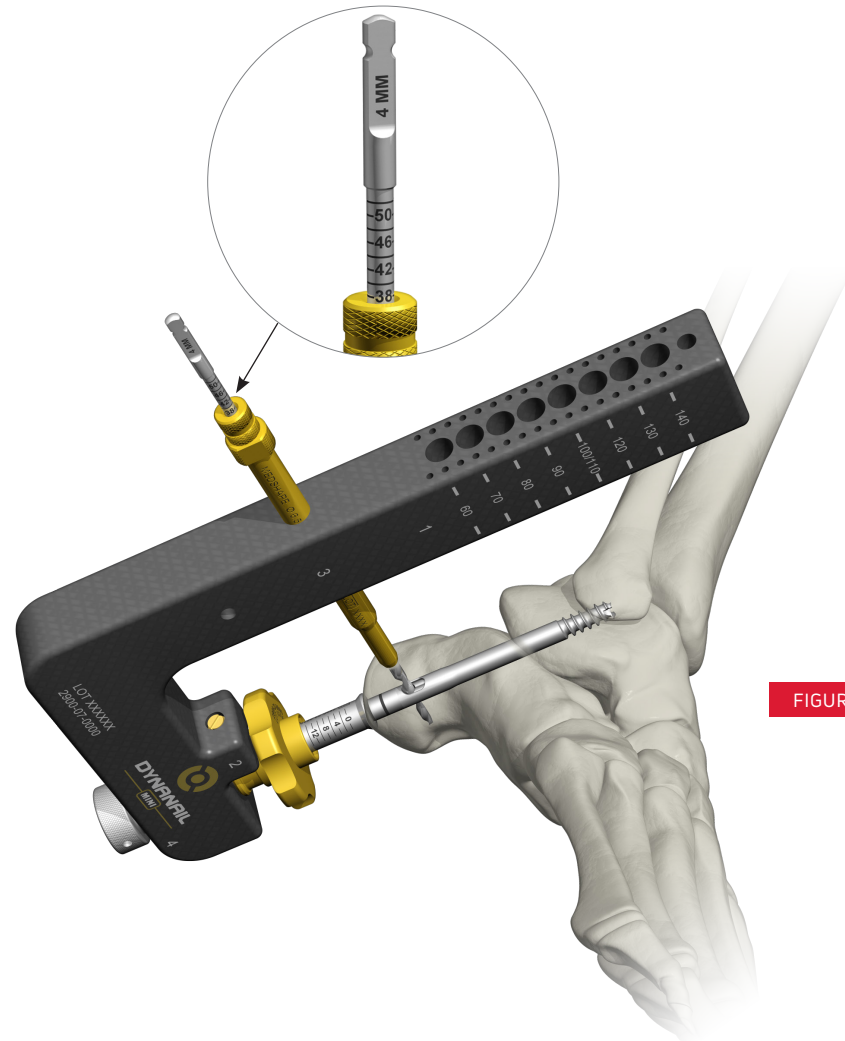

FIGURE 12

2. The Screw Depth Gauge may be inserted through the Drill Guide (A). With the Drill Guide against the bone (B), read the laser marks on the Depth Gauge off the back of the Drill Guide (FIGURE 13).

TIP:

Use A-P fluoroscopy to confirm the Drill has reached the medial cortex before reading lasermarks.

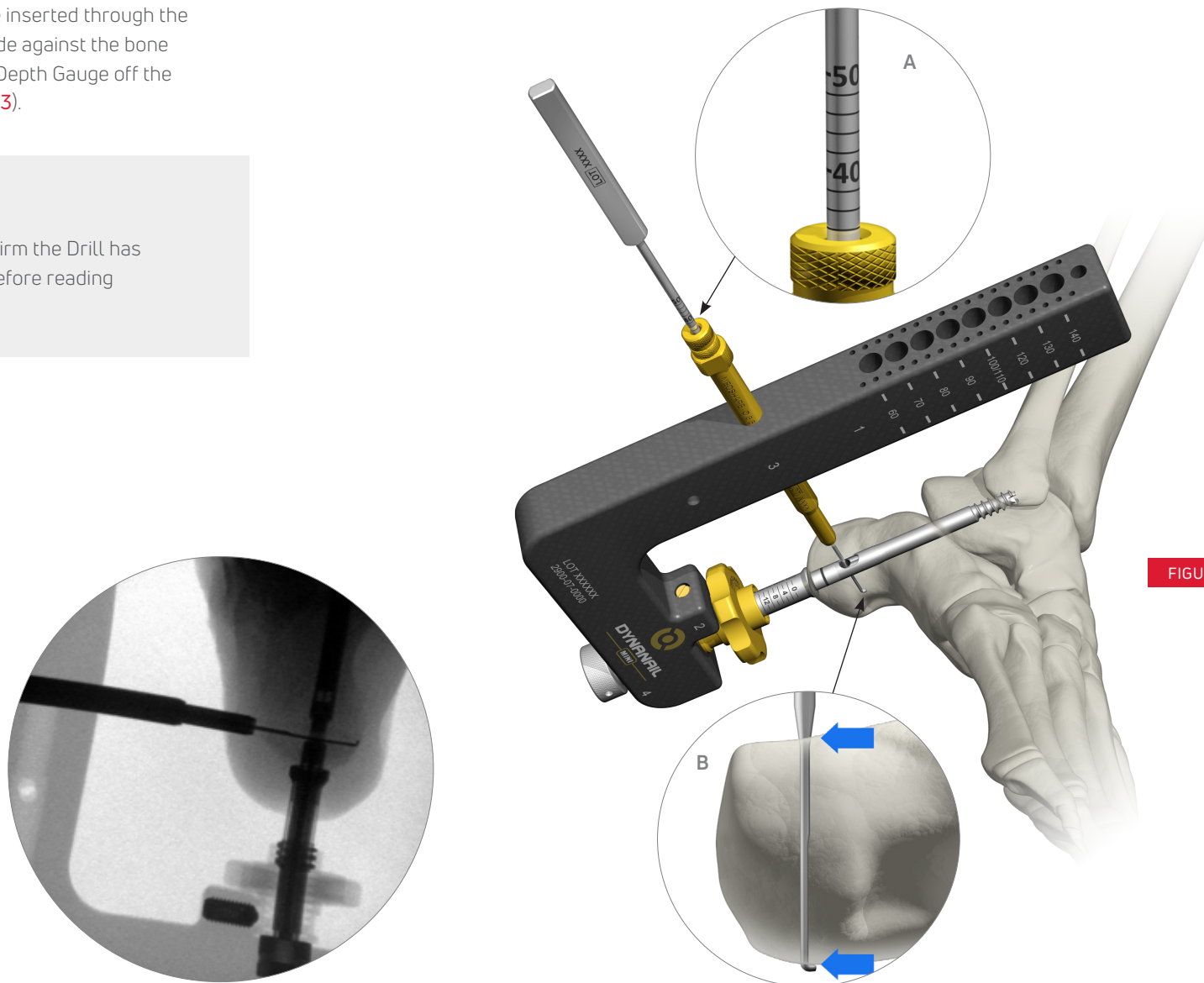

FIGURE 13

12. CALCANEAL SCREW INSERTION

Instruments used:

1. 6.5 mm Guide Sleeve (21)
2. 3mm Hex Driver (3)
3. Blue-Handle Ratchet Driver (4)
4. Headless Screw

Attach the 3 mm Hex Driver to the Blue Handle Ratchet Driver. Remove the 4 mm Drill and Drill Guide from the Guide Sleeve. Place the Headless Screw onto the 3 mm Hex Driver and insert into the Guide Sleeve (**FIGURE 14**).

The Headless Screw does not provide any tactile feedback to indicate when it is fully inserted. When the laser marking on the 3 mm Hex Driver approaches the back of the Guide Sleeve (**A**), use A-P fluoroscopy while advancing the final turns, ensuring the screw tip does not extend beyond the medial cortex of the talus. Remove the Hex Driver and Guide Sleeve from the Targeting Frame.

TIP:

Do NOT use power drill for insertion.

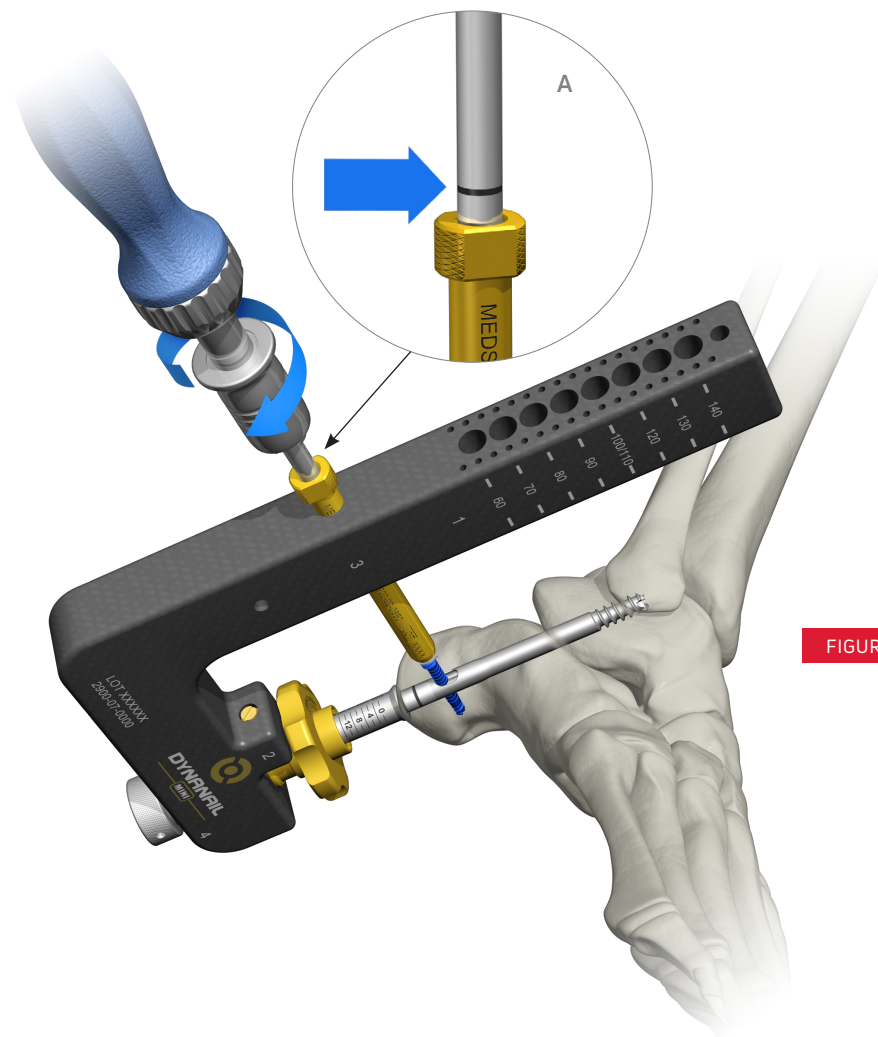

FIGURE 14

13. RELEASE NAIL

Instruments used:

1. 2 mm Hex Driver (2)
2. Blue-Handle Ratchet Driver (4)

Attach the 2 mm Hex Driver to the Blue Handle Ratchet Driver. Unscrew the Connection Screw to release the Implant from the Targeting Frame by turning the 2 mm Hex Driver counter-clockwise (FIGURE 15).

This will release the Sliding Element from the Nail Connection Guide and activate the NiTiNOL Compressive Element (A).

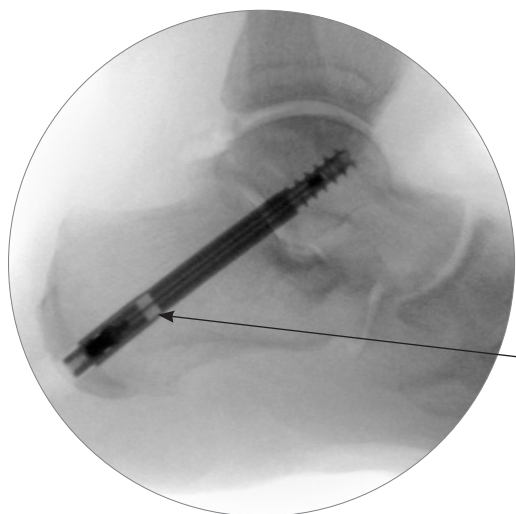
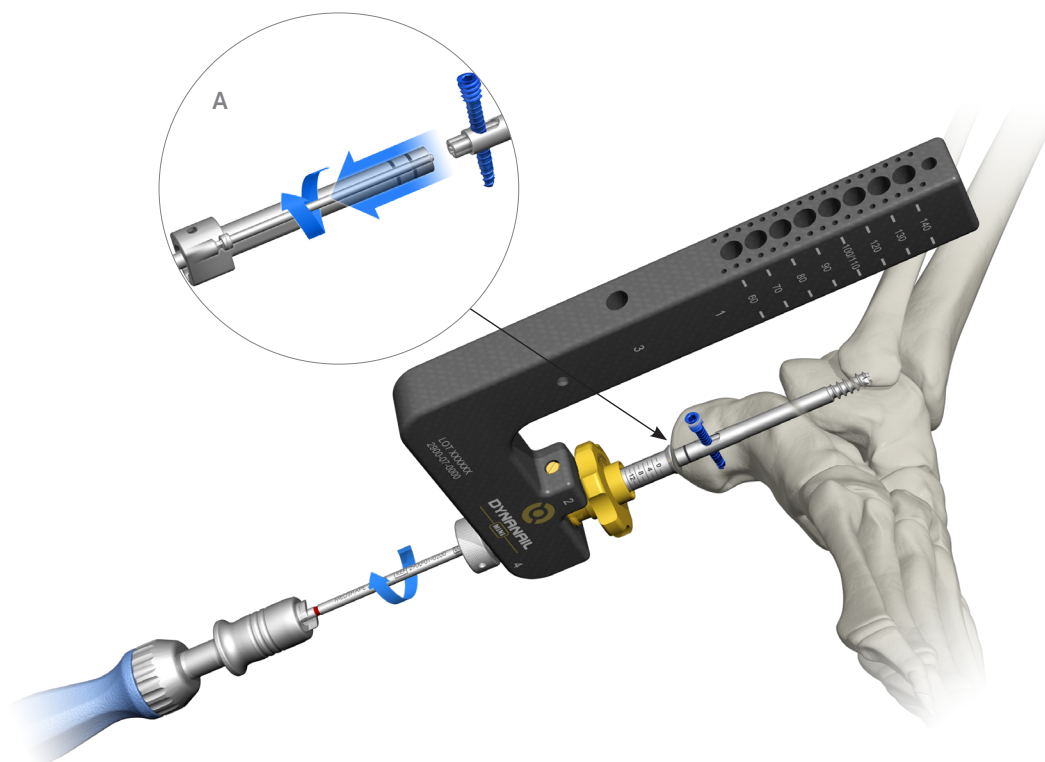

TRANSLUCENT REGION
SHOWS AVAILABLE AMOUNT
OF NITINOL COMPRESSION

FIGURE 15

14. ADD ENDCAP

Instruments used:

1. 2 mm T-Handle Driver (1)
2. End Cap

Select the desired End Cap size and place onto the end of the 2.0 mm T-Handle Driver (**FIGURE 16**). Thread the End Cap into the distal end of the Sliding Element in the Nail Implant (**A**) until finger tight.

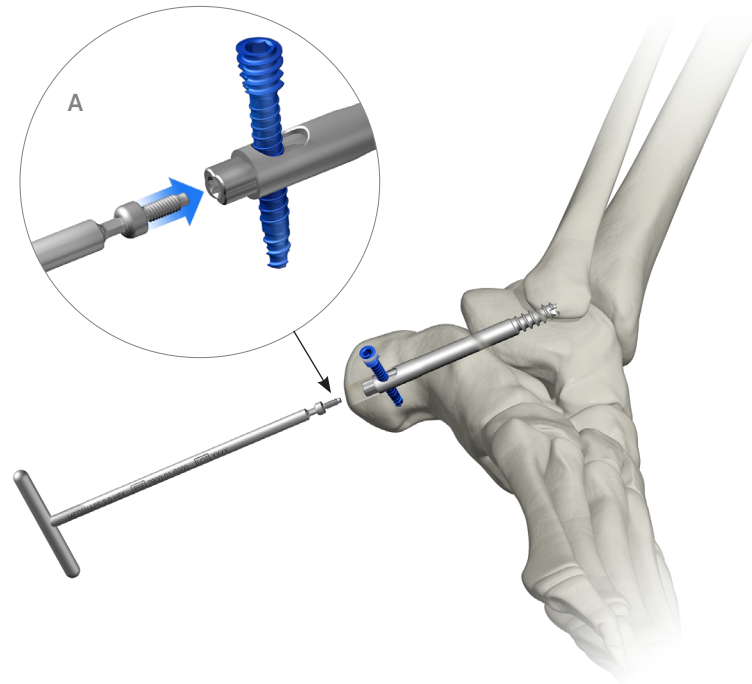

FIGURE 16

15. FINAL ASSESSMENT

Instruments used:

Check final positioning of nail using both A-P and lateral fluoroscopy.

Close incisions per surgeon preference.

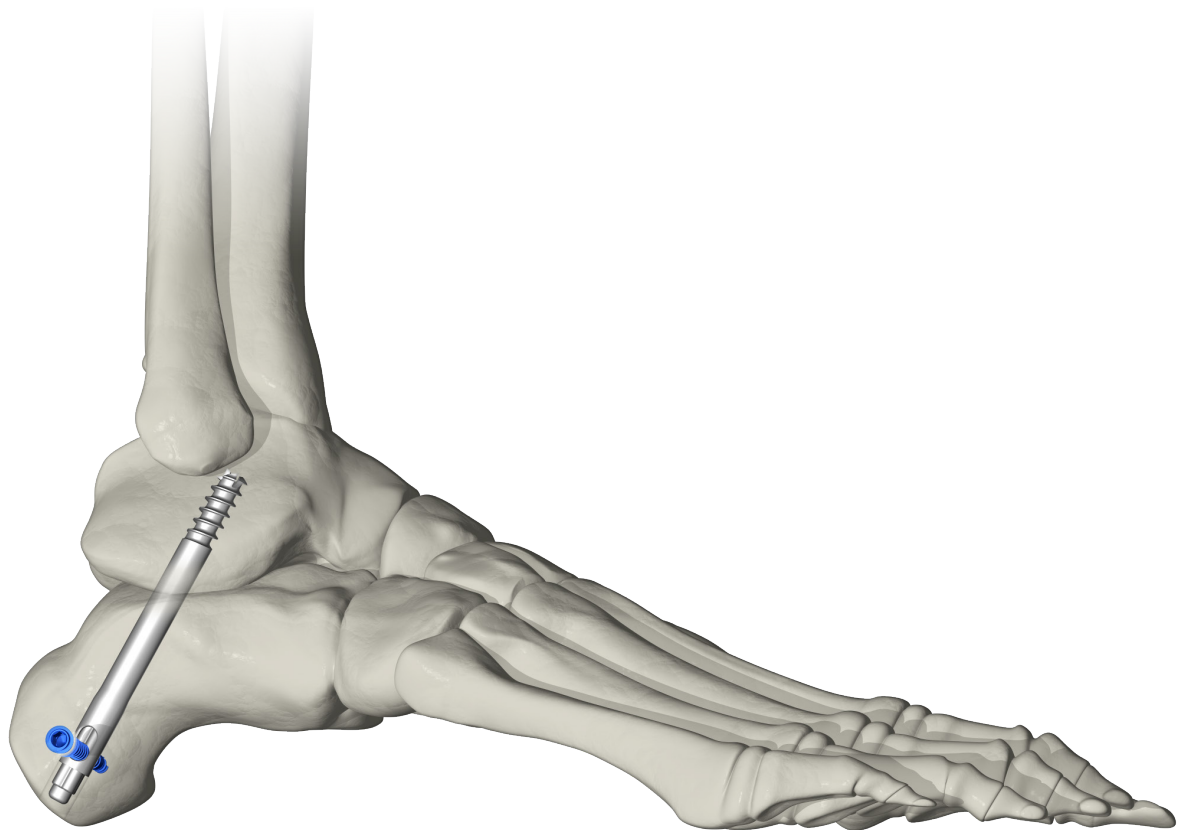

DYNANAIL HYBRID™ IMPLANTS

PART #	DESCRIPTION
2601-00-7060	DYNANAIL HYBRID, 7 MM X 60 MM
2601-00-7070	DYNANAIL HYBRID, 7 MM X 70 MM
2601-00-7080	DYNANAIL HYBRID, 7 MM X 80 MM
2601-00-7090	DYNANAIL HYBRID, 7 MM X 90 MM
2601-00-7100	DYNANAIL HYBRID, 7 MM X 100 MM
2600-03-4314	HEADLESS SCREW, 4 MM X 14 MM
2600-03-4316	HEADLESS SCREW, 4 MM X 16 MM
2600-03-4318	HEADLESS SCREW, 4 MM X 18 MM
2600-03-4320	HEADLESS SCREW, 4 MM X 20 MM
2600-04-4322	HEADLESS SCREW, 4 MM X 22 MM
2600-04-4324	HEADLESS SCREW, 4 MM X 24 MM
2600-04-4326	HEADLESS SCREW, 4 MM X 26 MM
2600-04-4328	HEADLESS SCREW, 4 MM X 28 MM
2600-04-4330	HEADLESS SCREW, 4 MM X 30 MM
2600-04-4332	HEADLESS SCREW, 4 MM X 32 MM
2600-04-4334	HEADLESS SCREW, 4 MM X 34 MM
2600-04-4336	HEADLESS SCREW, 4 MM X 36 MM
2600-04-4338	HEADLESS SCREW, 4 MM X 38 MM
2600-04-4340	HEADLESS SCREW, 4 MM X 40 MM
2600-05-0003	END CAP, +3MM OFFSET
2600-05-0006	END CAP, +6MM OFFSET

DYNANAIL HYBRID™ SINGLE USE INSTRUMENTS

PART #	DESCRIPTION
2200-19-0200	STEINMANN PIN, 2 MM X 9"
2201-09-0025	FENESTRATION DRILL, 2.5 MM X 6"
2900-16-050	CANNULATED DRILL, 5 MM
2900-16-070	CANNULATED DRILL, 7 MM
2900-16-075	CANNULATED DRILL, 7.5 MM
2900-16-080	CANNULATED DRILL, 8 MM
2900-16-085	CANNULATED DRILL, 8.5 MM
2900-03-0400	TRANSVERSE SCREW DRILL, 4 MM, STEPPED
2900-04-0229	GUIDEWIRE, 2.4 MM X 229 MM
2901-01-0075	CANNULATED STEP DRILL, 7.5 MM



T 800.456.8696 D 512.832.9500 F 512.834.6300
1575 Northside Dr NW | Suite 440 | Atlanta, GA 30318 | U.S.A.
djoglobal.com/foot-and-ankle

Copyright © 2021 by DJO, LLC
MK-10201 Rev 00

Individual results may vary. DJO, LLC is a manufacturer of orthopedic implants and does not practice medicine. Only an orthopedic surgeon can determine what treatment is appropriate. The contents of this document do not constitute medical, legal, or any other type of professional advice. This material is intended for the sole use and benefit of the DJO, LLC sales force and physicians. It is not to be redistributed, duplicated, or disclosed without the express written consent of DJO, LLC. For more information on risks, warnings, and possible adverse side effects refer to the Instructions for Use provided with the device.